



Radio | CD

Bristol CD36

7 646 075 310

Vancouver CD36

7 646 067 310

## Operating instructions



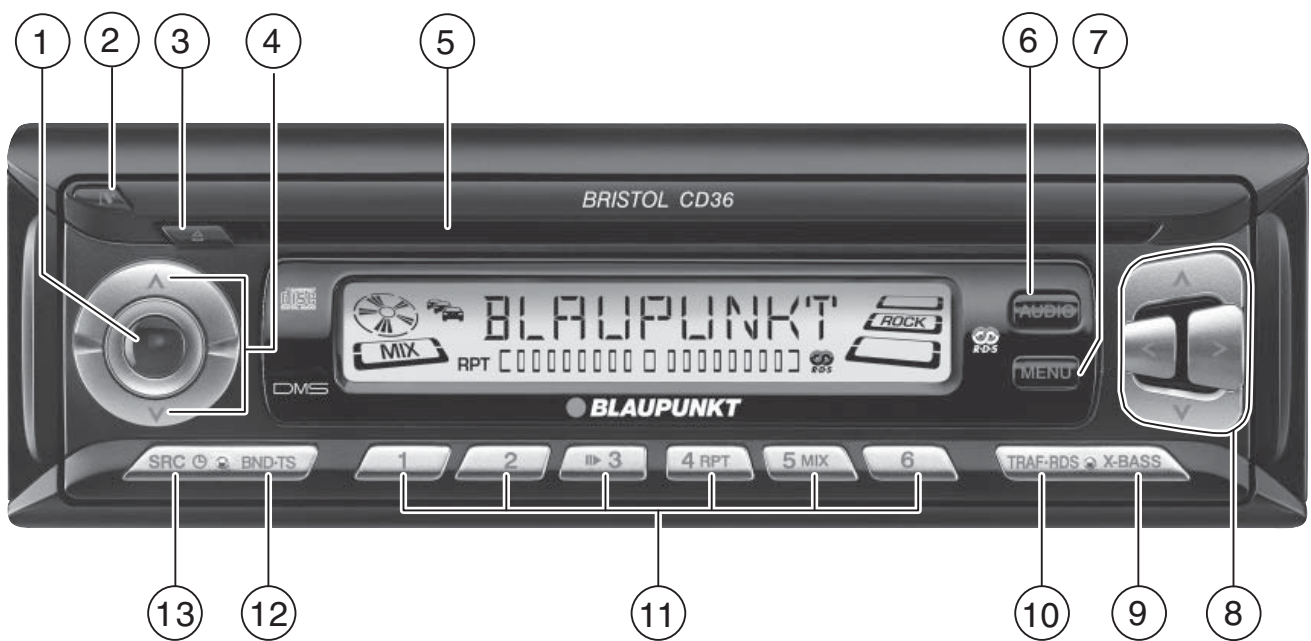

 **BLAUPUNKT**



# CONTROLS

---

- ① Button to switch the device on/off and operate the volume mute function.
- ②  button for detaching the control panel (release panel).
- ③  button to eject a CD from the device.
- ④ Volume control
- ⑤ CD compartment
- ⑥ **AUDIO** button to adjust the bass, treble, balance and fader. To select an equalizer preset.
- ⑦ **MENU** button  
Short press: Open the settings menu.  
Long press: Start the scan function.
- ⑧ Arrow buttons
- ⑨ **X-BASS** button to activate/deactivate and adjust the X-BASS.
- ⑩ **TRAF RDS** button  
Short press: Switch traffic-information standby on/off.  
Long press: Switch the RDS function on/off.
- ⑪ **Keys 1 - 6**
- ⑫ **BND•TS** button  
Short press: Select the FM memory banks and the MW and LW wavebands.  
Long press: Start the Travel-store function.
- ⑬ **SRC**  button  
Short press: Switch sources between CD, CD changer (if connected) and AUX.  
Long press: Briefly display the

<b>Notes and accessories</b> .....	<b>28</b>	Pausing playback (PAUSE) .....	40
<b>Removable control panel</b> .....	<b>29</b>	Configuring the display .....	40
<b>Switching on/off</b> .....	<b>30</b>	Traffic announcements in CD mode .....	40
<b>Adjusting the volume</b> .....	<b>31</b>	Ejecting a CD .....	41
Setting the power-on volume .....	31	<b>CD-changer mode</b> .....	<b>41</b>
Quick volume reduction (mute) ....	32	Switching to CD-changer mode ...	41
Switching the confirmation beep on/off .....	32	Selecting CDs .....	41
Mute while telephoning .....	32	Selecting tracks .....	41
<b>Radio mode</b> .....	<b>33</b>	Fast searching (audible) .....	41
Adjusting the tuner settings .....	33	Configuring the display .....	42
Switching to radio mode .....	33	Repeating individual tracks or whole CDs (REPEAT) .....	42
RDS functions .....	33	Random track play (MIX) .....	42
Selecting the waveband / memory bank .....	34	Scanning all the tracks on all the CDs (SCAN) .....	42
Tuning into a station .....	34	Pausing playback (PAUSE) .....	43
Setting the sensitivity of station seek tuning .....	35	<b>CLOCK time</b> .....	<b>43</b>
Storing stations .....	35	<b>Sound</b> .....	<b>44</b>
Storing stations automatically (Travelstore) .....	35	Adjusting the bass .....	44
Listening to stored stations .....	35	Adjusting the treble .....	44
Scanning receivable stations (SCAN) .....	35	Setting the left/right volume distribution (balance) .....	45
Setting the scanning time .....	36	Adjusting the front/rear volume distribution (fader) .....	45
Programme type (PTY) .....	36	Equalizer presets .....	45
Optimising radio reception .....	37	<b>X-BASS</b> .....	<b>46</b>
Configuring the display .....	37	<b>Configuring the level display</b> ..	<b>46</b>
<b>Traffic information</b> .....	<b>38</b>	<b>External audio sources</b> .....	<b>47</b>
<b>CD mode</b> .....	<b>39</b>	<b>Specifications</b> .....	<b>47</b>
Switching to CD mode .....	39		
Selecting tracks .....	39		
Fast track selection .....	39		
Fast searching (audible) .....	39		
Random track play (MIX) .....	39		
Scanning tracks (SCAN) .....	40		
Repeating tracks (REPEAT) .....	40		

# NOTES AND ACCESSORIES

## Notes and accessories

Thank you for choosing a Blaupunkt product. We hope you enjoy using this new piece of equipment.

**Please read these operating instructions before using the equipment for the first time.**

The Blaupunkt editors are constantly working on making the operating instructions clearer and easier to understand. However, if you still have any questions on how to operate the device, please contact your dealer or the telephone hotline for your country. You will find the telephone number printed at the back of this booklet.

We provide a manufacturer guarantee on our products bought within the European Union. You can view the guarantee conditions at [www.blaupunkt.de](http://www.blaupunkt.de) or ask for them directly at:

Blaupunkt GmbH  
Hotline  
Robert Bosch Str. 200  
D-31139 Hildesheim  
Germany

## Disposal of old unit (EU countries only)



Do not dispose of your old device in the household trash!

Use the return and collection systems available to dispose of the old device.

## Road safety

 Road safety has absolute priority. Only operate your car sound system if the road and traffic conditions allow you to do so. Familiarise yourself with the device before setting off on your journey.

You must always be able to hear police, fire service and ambulance sirens in good time from inside your vehicle. For this reason, listen to your car sound system at a moderate volume level during your journey.

## Installation

If you want to install your car sound system yourself, please read the installation and connection instructions that follow these operating instructions.

## Optional equipment

**(not part of the scope of delivery)**

Use only accessories approved by Blaupunkt.

## Remote control

The steering wheel and/or handheld remote control allows you to access the most important functions of your car sound system safely and conveniently.

You cannot switch the device on/off using the remote control.

You can find out from your Blaupunkt dealer or on the Internet at [www.blaupunkt.com](http://www.blaupunkt.com) which remote controls can be used with your car sound system.

## Amplifiers

You can use all Blaupunkt and Velocity amplifiers.

## CD changers

You can connect the following Blaupunkt CD changers: CDC A 08, IDC A 09 and CDC A 03.

## Removable control panel

### Theft protection

As a way of protecting your car radio against theft, the unit is equipped with a removable control panel (release panel). Without this control panel, the car radio is worthless to a thief.

Protect your car radio against theft by taking the control panel with you every time you leave your vehicle. Do not leave the control panel in your vehicle - not even in a hiding place.

The control panel has been designed to be easy to use.

### **Notes:**

- Never drop the control panel.
- Never expose the control panel to direct sunlight or other heat sources.
- Avoid making direct skin contact with the control panel's contacts. If necessary, clean the contacts with a lint-free cloth and some alcohol.

### Removing the control panel

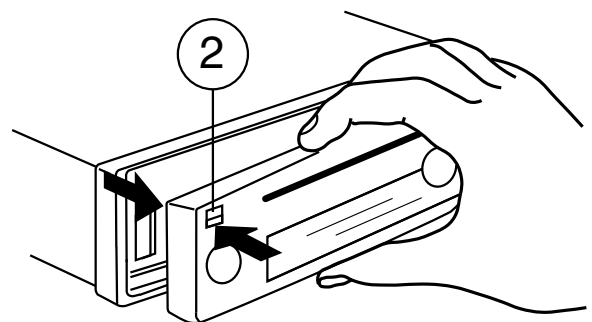

⇒ Press the  button (2).

The control panel locking mechanism opens.

- ⇒ First, pull the control panel straight off the unit and then out towards the left.

The device switches off.

All the current settings are saved.

Any CD already inserted in the unit remains there.

### Attaching the control panel

- ⇒ Slide the control panel from left to right into the unit's guide.
- ⇒ Carefully press on the left edge of the control panel until it clicks into place.

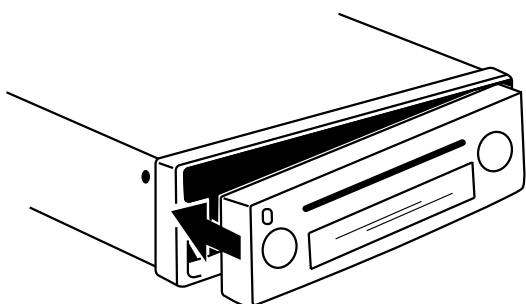

#### **Note:**

- When attaching the control panel, make sure you do not press the display.

If the device was still switched on when you removed the control panel, it will automatically switch on again with the last settings activated (i.e. radio, CD, CD changer or AUX) when the panel is replaced.

### **Switching on/off**

You can switch the device on/off in the following ways:

#### **Switching on/off using the vehicle ignition**

If the device is correctly connected to the vehicle's ignition and it was not switched off using button ①, it will switch on/off simultaneously with the ignition.

#### **Switching on/off using button ①**

- ⇒ To switch on the device, press button ①.
- ⇒ To switch off the device, press and hold down button ① for longer than two seconds.

The device switches off.

#### **Note:**

- To protect the vehicle battery, the device will switch off automatically after one hour if the ignition is off.

#### **Switching on by inserting a CD**

If the device is switched off and there is no CD present in the drive,

- ⇒ gently push the CD with its printed side uppermost into the drive ⑤ until you feel some resistance.

The drive draws in the CD automatically.

You must not hinder or assist the drive as it draws in the CD.

The device switches on and starts playing the CD.

## Note:

- If the vehicle ignition was switched off before you inserted the CD, you will first have to switch on the device by pressing button ① in order to start playing the CD.

## Switching on/off using the removable control panel

- ⇒ Remove the control panel.

The unit switches off.

- ⇒ Attach the control panel again.

The unit switches on. The settings (radio, CD, CD changer or AUX) that were set before the unit was switched off will be reactivated.

## Adjusting the volume

You can adjust the volume in steps from 0 (off) to 66 (maximum).

To increase the volume,

- ⇒ press the **▲** button ④.

To decrease the volume,

- ⇒ press the **▼** button ④.

## Setting the power-on volume

### Note:

- The device is equipped with a timeout function. If, for instance, you press the **MENU** button ⑦ and select a menu item, the device will switch back approx. 8 seconds after the last button was pressed. Any changes to the settings that you have made will be saved.

You can set the power-on volume.

- ⇒ Press the **MENU** button ⑦.

- ⇒ Press the **▼** or **▲** button ⑧ repeatedly until "ON VOLUME" appears in the display.

- ⇒ Adjust the power-on volume using the **<>** buttons ⑧.

To help you adjust the setting more easily, the device will increase or decrease the volume as you make your changes.

If you change the setting to "LAST VOL", the volume level that was set the last time you switched off the device will be activated again.



# ADJUSTING THE VOLUME

---

## Note:

- To protect your hearing, the power-on volume is limited to a value of “38”. If the volume level was higher than this when the device was last switched off and the “LAST VOL” setting is activated, the system will reset the volume to “38” when you switch the device on again.

When you have finished adjusting the setting,

- ⇒ press the **MENU** button (7) twice.

## Quick volume reduction (mute)

You can quickly decrease the volume (mute) to a level preset by you.

- ⇒ **Briefly** press button (1).

“MUTE” appears in the display.

## Canceling mute

To return to your previously set volume level,

- ⇒ **briefly** press button (1) again.

## Setting the mute level

You can adjust the mute level.

- ⇒ Press the **MENU** button (7).
- ⇒ Press the **▼** or **▲** button (8) repeatedly until “MUTE LVL” appears in the display.
- ⇒ Adjust the mute level using the **<>** buttons (8).

When you have finished adjusting the setting,

- ⇒ press the **MENU** button (7) twice.

## Switching the confirmation beep on/off

The system will play a confirmation beep for some functions if you keep a button pressed down for longer than two seconds, for instance, when you assign a radio station to a station button. You can switch the beep on/off.

- ⇒ Press the **MENU** button (7).
- ⇒ Press the **▼** or **▲** button (8) repeatedly until “BEEP ON” or “BEEP OFF” appears in the display.
- ⇒ Activate/deactivate the beep using the **<>** buttons (8). “OFF” means the beep is switched off and “ON” means the beep is switched on.

When you have finished adjusting the setting,

- ⇒ press the **MENU** button (7).

## Mute while telephoning

If your device is connected to a mobile telephone, the car radio’s volume will be muted as soon as you “pick up” the telephone. This requires that the mobile telephone be connected to the device as described in the installation instructions.

“PHONE” appears in the display.

## Radio mode

### Adjusting the tuner settings

To ensure that the tuner works properly, the device must be configured for the region in which it is being used. You can choose between Europe (EUROPE), United States (USA), South America (S-AMERICA) and Thailand (THAI). By default, the tuner is set to the region in which the device was sold. If you encounter problems with radio reception, please check this setting.

The radio functions described in these operating instructions refer to the EUROPE tuner setting.

⇒ Switch the device off using button ①.

⇒ Press and hold down the **1** and **5** buttons ⑪ simultaneously and switch on the device again by pressing button ①.

“TUNER” is displayed.

⇒ Select your tuner region using the **V** or **^** button ⑧.

To save the setting,

⇒ switch the device off and on again or wait approx. 8 seconds. The car sound system switches on and the mode that was selected last is activated (radio, CD, CD changer or AUX).

### Switching to radio mode

If you are in CD, CD-changer or AUX mode,

⇒ press the **BND•TS** button ⑫

or

⇒ press the **SRC** ⑬ button ⑬ repeatedly until the memory bank (e.g. “FM1”) appears in the display.

### RDS functions

This device is equipped with an RDS radio receiver (**R**adio **D**ata **S**ystem). Many of the receivable FM stations broadcast a signal that not only carries the programme but also additional information such as the station name and programme type (PTY).

The station name appears in the display as soon as the tuner receives it.

The convenient RDS functions AF (Alternative Frequency) and REGIONAL extend your radio’s range of functions.

- **AF:** If the RDS function is activated, the radio automatically tunes into the best receivable frequency for the station that is currently set.
- **REGIONAL:** At certain times, some radio stations divide their programme into regional programmes providing different content. You can use the REG function to prevent the car radio from switching to alternative frequencies that are broadcasting different programme content.

#### **Note:**

- **REGIONAL** must be activated/deactivated separately in the menu.

# RADIO MODE

---

## Switching the RDS function on/off

If you want to use the RDS functions (AF and REGIONAL),

- ⇨ press and hold down the **TRAF RDS** button (10) for longer than two seconds.

The RDS function is active when the RDS symbol is shown in the display.

## Switching REGIONAL on/off

- ⇨ Press the **MENU** button (7).
- ⇨ Press the **V** or **^** button (8) repeatedly until “REG” appears in the display. “OFF” or “ON” is displayed alongside “REG”.
- ⇨ To switch REGIONAL on/off, press the **>** or **<** button (8).
- ⇨ Press the **MENU** button (7).

## Selecting the waveband / memory bank

You can use this device to receive programmes broadcast over the FM frequency range as well as the MW and LW (AM) wavebands. There are three memory banks available for the FM waveband (FM1, FM2 and FMT) and one for each of the MW and LW wavebands. Six stations can be stored in each memory bank.

To switch between the FM memory banks (FM1, FM2 and FMT) and the MW and LW wavebands,

- ⇨ briefly press the **BND•TS** button (12).

## Tuning into a station

There are various ways of tuning into a station.

### Automatic station seek tuning

- ⇨ Press the **V** or **^** button (8).

The radio tunes into the next receivable station.

### Tuning into stations manually

You can also tune into stations manually.

#### Note:

- You can only tune into stations manually if the RDS function is deactivated.

- ⇨ Press the **<** or **>** button (8).

### Browsing through broadcasting networks (only FM)

If radio stations provide several programmes, you have the option of browsing through their “broadcasting networks”.

#### Note:

- The RDS function must be activated before you can use this feature.

- ⇨ Press the **<** or **>** button (8) to switch to the next station on the broadcasting network.

#### Note:

- When using this feature, you will only be able to switch to stations that you have received once before already. To receive the stations, use the scan function or the Travelstore function.

## Setting the sensitivity of station seek tuning

You can choose whether the radio should only tune into stations providing good reception or whether it can also tune into those with a weak reception.

- ⇨ Press the **MENU** button (7).
- ⇨ Press the **V** or **^** button (8) repeatedly until “SENS” and the currently set value appear in the display.

“SENS HI6” means that the tuner is set to the highest sensitivity setting. “SENS LO1” means it is set to the lowest sensitivity setting.

- ⇨ Set the desired sensitivity using the **<>** buttons (8).

When you have finished adjusting the setting,

- ⇨ press the **MENU** button (7).

### **Note:**

- You can set different sensitivity levels for FM and MW or LW (AM).

## Storing stations

### Storing stations manually

- ⇨ Select the memory bank that you want (FM1, FM2, FMT) or one of the wavebands (MW or LW).
- ⇨ Tune into the station that you want.
- ⇨ Press and hold down one of the station buttons **1 - 6** (11) for longer than two seconds to assign the station to that button.

## Storing stations automatically (Travelstore)

You can automatically store the six stations providing the best reception in the region (only FM). The stations are stored in the FMT memory bank.

### **Note:**

- Any stations previously stored in this memory bank are deleted in the process.
- ⇨ Press and hold down the **BND•TS** button (12) for longer than two seconds.

The storing procedure begins. “FM TSTORE” appears in the display. After the process has completed, the radio will play the station that is stored in memory location 1 of the FMT memory bank.

## Listening to stored stations

- ⇨ Select the memory bank or waveband.
- ⇨ Press the station button **1 - 6** (11) that corresponds to the station that you want to listen to.

## Scanning receivable stations (SCAN)

You can use the scan function to listen to all the receivable stations briefly. You can set the scanning time in the menu to between 5 and 30 seconds (in steps of 5 seconds).

### **Starting SCAN**

- ⇨ Press and hold down the **MENU** button (7) for longer than two seconds.

# RADIO MODE

Scanning begins. "SCAN" appears briefly in the display followed by a flashing display of the current station name or frequency.

## Cancelling SCAN and continuing listening to a station

⇨ Press the **MENU** button (7).

Scanning stops and the radio continues playing the station that it tuned into last.

## Setting the scanning time

⇨ Press the **MENU** button (7).

⇨ Press the **V** or **^** button (8) repeatedly until "SCAN TIME" appears in the display.

⇨ Set the desired scanning time using the **<>** buttons (8).

When you have finished adjusting the setting,

⇨ press the **MENU** button (7) twice.

### **Note:**

- The scanning time that you set is also used when scanning in CD mode and in CD-changer mode.

## Programme type (PTY)

Besides transmitting the station name, some FM stations also provide information on the type of programme they are broadcasting. Your car radio can receive and display this information.

For example, the programme types can be:

CULTURE	TRAVEL	JAZZ
SPORT	NEWS	POP
ROCK	CLASSICS	

You can use the PTY function to select stations of a particular programme type.

## PTY-EON

If you specify the programme type and start seek tuning, the radio will switch from the current station to a station of the selected programme type.

### **Notes:**

- If the tuner does not find a station that matches the selected programme type, you will hear a beep and "NO PTY" appears briefly in the display. The radio will then retune to the station that it received last.
- If the tuned radio station or another station on the broadcasting network broadcasts your selected programme type at a later point in time, the radio will automatically switch from the currently tuned station or from CD mode or CD-changer mode to the station whose programme type matches the one you selected.
- If you do not want this PTY EON switching, disable it in the menu with "PTY OFF". First, press one of the **SRC** (13) or **BND•TS** buttons (12).

## Switching PTY on/off

⇨ Press the **MENU** button (7).

⇨ Press the **V** or **^** button (8) repeatedly until "PTY ON" or "PTY OFF" appears in the display.

⇨ Press the **>** or **<** button (8) to switch PTY ON or OFF.

⇨ Press the **MENU** button (7).

## Selecting the PTY language

You can select the language in which the programme types are displayed. The following are available: “DEUTSCH”, “ENGLISH” and “FRANÇAIS”.

⇨ Press the **MENU** button (7).

⇨ Press the **V** or **^** button (8) repeatedly until “PTY LANG” appears in the display.

⇨ Set your preferred language using the **<>** buttons (8).

When you have finished adjusting the setting,

⇨ press the **MENU** button (7) twice.

## Selecting a programme type and starting seek tuning

⇨ Press the **<** or **>** button (8).

The current programme type appears in the display.

⇨ If you want to select another programme type, you can do so by pressing the **<** or **>** button (8) whilst this display is visible.

The selected programme type appears briefly in the display.

⇨ Press the **V** or **^** button (8) to start seek tuning.

The radio will then tune into the next station it finds that matches your selected programme type.

## Optimising radio reception

### HICUT

The HICUT function improves reception during poor radio reception (only FM). If interference occurs, the interference level is cut automatically.

### Switching HICUT on/off

⇨ Press the **MENU** button (7).

⇨ Press the **V** or **^** button (8) repeatedly until “HICUT” appears in the display.

⇨ Press the **<** or **>** button (8) to adjust the HICUT setting.

“HICUT 0” means that the interference level will not be cut automatically. “HICUT 1” means that it will be cut automatically.

⇨ Press the **MENU** button (7).

## Configuring the display

In radio mode you have the option of displaying the waveband together with the memory bank / memory location and the time or the station name / frequency of the current station.

Select “FREQUENCY” to display the station name / frequency or select “CLOCK” to display the waveband together with the memory bank / memory location and the clock time.

⇨ Press the **MENU** button (7).

⇨ Press the **V** or **^** button (8) repeatedly until “TUN DISP” appears in the display.

⇨ Press the **<** or **>** button (8) to switch between “CLOCK” and “FREQUENCY”.

⇨ Press the **MENU** button (7) twice.

# TRAFFIC INFORMATION

## Traffic information

Your device is equipped with an RDS-EON receiver. EON stands for **E**nanced **O**ther **N**etwork.

Whenever a traffic announcement (TA) is broadcast, the system switches automatically from a station that does not provide traffic reports to the appropriate traffic information station within the broadcasting network that does.

Once the traffic report has been played, the system will switch back to the programme you were listening to before.

## Switching traffic information priority on/off

⇒ Briefly press the **TRAF RDS** button (10).

Traffic announcement priority is active when the traffic-jam symbol lights up in the display.

### Notes:

You will hear a warning beep:

- if you leave the reception area of a traffic information station that you are currently listening to.
- if you are receiving a traffic information station and the volume is set to minimum (0) or if, whilst listening to a CD, a CD in the changer or an AUX source, you leave the reception area of the tuned traffic information station and the subsequent automatic search cannot find a new traffic information station.

- if you retune the radio from a traffic information station to a station that does not broadcast traffic information.

If you hear the warning beep, you can either switch off traffic information priority or tune into a station that broadcasts traffic information.

## Setting the volume for traffic announcements

- ⇒ Press the **MENU** button (7).
- ⇒ Press the **V** or **Λ** button (8) repeatedly until “TA VOLUME” appears in the display.
- ⇒ Adjust the volume using the **<>** buttons (8).

When you have finished adjusting the setting,

- ⇒ press the **MENU** button (7) twice.

### Notes:

- You can use the volume control (4) to adjust the volume during a traffic announcement for the duration of that announcement.
- You can set the volume distribution for the traffic announcements. For further details, please read the “Sound” chapter.

## CD mode

You can use this device to play standard audio CDs, CD-Rs and CD-RWs with a diameter of 12 or 8 cm.

 Risk of severe damage to the CD drive!

Contoured CDs (shape CDs) are not suitable for playback in this unit. We do not accept responsibility for any damage to the CD drive that may occur as a result of the use of unsuitable CDs.

To ensure the system functions properly, only use CDs labelled with the compact disc logo. Problems might be experienced when playing copy-protected CDs. Blaupunkt cannot guarantee the proper functioning of copy-protected CDs!

### Switching to CD mode

If there is no CD inserted in the drive,

- ⇒ gently push the CD with the printed side uppermost into the CD compartment (5) until you feel some resistance.

The drive draws in the CD automatically.

You must not assist or hinder the drive as it draws in the CD.

The CD starts playing.

#### Note:

- If the vehicle ignition was switched off before you inserted the CD, you will first have to switch on the device by pressing button (1) in order to start playing the CD.

If there is already a CD inserted in the drive,

- ⇒ press the **SRC** (13) button repeatedly until "CD" appears in the display.

Playback begins from the point at which it was last interrupted.

### Selecting tracks

- ⇒ Press one of the arrow buttons (8) to select the next or previous track.

If you press the **V** or **<** button (8) once, the current track will be played again from the beginning.

### Fast track selection

For fast track selection (backwards or forwards),

- ⇒ press and hold down one of the **^ V** buttons (8) until fast-reverse / fast-forward track selection begins.

### Fast searching (audible)

For fast searching (backwards or forwards),

- ⇒ press and hold down one of the **<>** buttons (8) until fast searching backwards / forwards begins.

### Random track play (MIX)

- ⇒ Press the **5 MIX** button (11).

"MIX CD" appears briefly in the display and the MIX symbol lights up. The next randomly selected track will then be played.



# CD MODE

## Cancelling MIX

⇨ Press the **5 MIX** button (11) again. “MIX OFF” appears briefly in the display and the MIX symbol disappears.

## Scanning tracks (SCAN)

You can scan (briefly play) all the tracks on the CD.

⇨ Press and hold down the **MENU** button (7) for longer than two seconds.

The next track will then be scanned.

### Note:

- You can set the scanning time. For further details, please read the section entitled “Setting the scanning time” in the “Radio mode” chapter.

## Cancelling SCAN and continuing listening to a track

⇨ To cancel scanning, press the **MENU** button (7).

The currently scanned track will then continue to be played normally.

## Repeating tracks (REPEAT)

If you want to repeat a track,

⇨ press the **4 RPT** button (11).

“RPT TRCK” appears briefly in the display and the RPT symbol lights up. The track is repeated continuously until you deactivate RPT.

## Cancelling REPEAT

If you want to cancel the repeat function,

⇨ press the **4 RPT** button (11) again.

“RPT OFF” appears briefly in the display and the RPT symbol disappears. Normal playback is then resumed.

## Pausing playback (PAUSE)

⇨ Press button **3** (11).

“PAUSE” appears in the display.

## Cancelling pause

⇨ Press button **3** (11) whilst pause is activated.

Playback is resumed.

## Configuring the display

You can choose between two display types for CD mode:

- Track number and clock time
  - Track number and playing time
- ⇨ Press the **MENU** button (7).
- ⇨ Press the **V** or **^** button (8) repeatedly until “CD DISP” appears in the display.
- ⇨ Press the **<** or **>** button (8) to switch between “PLAY TIME” and “CLOCK”.
- ⇨ Press the **MENU** button (7) twice.

## Traffic announcements in CD mode

If you wish to receive traffic announcements whilst CD mode is activated,

⇨ press the **TRAF RDS** button (10).

Traffic announcement priority is active when the traffic jam symbol is shown in the display. For further details, please read the “Traffic information reception” chapter.

### Ejecting a CD

- ⇒ Press the **▲** button (3) next to the CD compartment.

The CD is ejected.

- ⇒ Remove the CD.

#### **Notes:**

- If a CD is ejected, the drive will automatically draw it back in again after approx. 10 seconds.
- You can also eject CDs whilst the device is switched off or whilst another audio source is activated.

### **CD-changer mode**

#### **Note:**

- Information on handling CDs, inserting CDs and operating the CD changer can be found in the operating instructions supplied with your CD changer.

### Switching to CD-changer mode

- ⇒ Press the **SRC** **⏻** button (13) repeatedly until “CHANGER” appears in the display.

The device starts playing the first CD that the CD changer detects.

### Selecting CDs

To move up or down to another CD,

- ⇒ press the **▼** or **▲** button (8) once or several times.

#### **Note:**

- The device will ignore empty CD slots in the changer and slots containing invalid CDs.

### Selecting tracks

To move up or down to another track on the current CD,

- ⇒ press the **<** or **>** button (8) once or several times.

### Fast searching (audible)

For fast searching (backwards or forwards),

- ⇒ press and hold down one of the **<>** buttons (8) until fast searching backwards / forwards begins.

# CD-CHANGER MODE

## Configuring the display

There are five display options available for CD-changer mode:

- Track number and playing time (“TRCK-TIME”)
- Track number and clock time (“TRCK-CLK”)
- CD number and track number (“CD-TRCK”)
- CD number and clock time (“CD-CLK”)
- CD number and playing time (“CD-TIME”)

- ⇒ Press the **MENU** button (7).
- ⇒ Press the **V** or **^** button (8) repeatedly until “CDC DISP” appears in the display.
- ⇒ Press the **<** or **>** button (8) repeatedly until the option that you want is displayed.
- ⇒ Press the **MENU** button (7) twice.

## Repeating individual tracks or whole CDs (REPEAT)

To repeat the current track,

- ⇒ briefly press the **4 RPT** button (11).

“RPT TRCK” appears briefly and RPT lights up in the display.

To repeat the current CD,

- ⇒ press and hold down the **4 RPT** button (11) for longer than two seconds.

“RPT DISC” appears briefly and RPT lights up in the display.

## Cancelling REPEAT

To stop the current track or current CD from being repeated,

- ⇒ briefly press the **4 RPT** button (11).

“RPT OFF” appears and RPT disappears from the display.

## Random track play (MIX)

To play the tracks on the current CD in random order,

- ⇒ briefly press the **5 MIX** button (11).

“MIX CD” appears briefly and MIX lights up in the display.

To play the tracks on all the inserted CDs in random order,

- ⇒ press and hold down the **5 MIX** button (11) for longer than two seconds.

“MIX ALL” appears briefly and MIX lights up in the display.

## Cancelling MIX

- ⇒ Briefly press the **5 MIX** button (11).

“MIX OFF” appears and MIX disappears from the display.

## Scanning all the tracks on all the CDs (SCAN)

To scan (briefly play) all the tracks on all the inserted CDs in ascending order,

- ⇒ press and hold down the **MENU** button (7) for longer than two seconds.

“TRK SCAN” appears in the display and the number of the current track flashes.

**Cancelling SCAN**

To stop scanning,

- ⇨ briefly press the **MENU** button (7).

The currently scanned track will then continue to be played normally.

**Note:**

- You can set the scanning time. For further details, please read the section entitled “Setting the scanning time” in the “Radio mode” chapter.

**Pausing playback (PAUSE)**

- ⇨ Press button **3**  (11).

“PAUSE” appears in the display.

**Cancelling pause**

- ⇨ Press button **3**  (11) whilst pause is activated.

Playback is resumed.

**CLOCK time****Displaying the clock time**

To display the clock time briefly,

- ⇨ press and hold down the **SRC**  button (13) until the clock time appears in the display.

**Setting the clock time**

To set the clock time,

- ⇨ press the **MENU** button (7).
- ⇨ Press the **V** or **^** button (8) repeatedly until “CLOCK SET” appears in the display.
- ⇨ Press the **<** button (8).

The clock time appears in the display. The hours flash and can be adjusted.

- ⇨ Adjust the hours using the **^** **V** buttons (8).

Once the hours are set,

- ⇨ press the **>** button (8).

The minutes flash.

- ⇨ Adjust the minutes using the **^** **V** buttons (8).
- ⇨ Press the **MENU** button (7) twice.

**Selecting 12/24-hour clock mode**

- ⇨ Press the **MENU** button (7).

“MENU” appears in the display.

- ⇨ Press the **V** or **^** button (8) repeatedly until “24 H MODE” or “12 H MODE” appears in the display.
- ⇨ Press the **<** or **>** button (8) to switch between the modes.

When you have finished adjusting the setting,

- ⇒ press the **MENU** button (7).

## Displaying the time continuously when the device is off and the ignition is on

To display the time when the device is off and the vehicle ignition is on,

- ⇒ press the **MENU** button (7).  
“MENU” appears in the display.
- ⇒ Press the **V** or **Λ** button (8) repeatedly until “CLOCK OFF” or “CLOCK ON” appears in the display.
- ⇒ Press the **<** or **>** button (8) to switch between the ON/OFF settings.

When you have finished adjusting the setting,

- ⇒ press the **MENU** button (7).

## Briefly displaying the time when the device is switched off

To display the time briefly when the device is off,

- ⇒ press the **SRC** (13) button (13).  
The time is displayed for approx. 8 seconds.

## Sound

You can adjust the sound settings (bass and treble) separately for each source (radio, CD, CD changer or AUX).

The volume distribution settings (balance and fader) apply to all the audio sources (except for traffic announcements).

You can **only** adjust the balance and fader settings for traffic announcements **whilst** a traffic announcement is actually being played.

### Adjusting the bass

- ⇒ Press the **AUDIO** button (6).  
“BASS” appears in the display.
- ⇒ Press the **V** or **Λ** button (8) to adjust the bass.

When you have finished adjusting the setting,

- ⇒ press the **AUDIO** button (6).

### Adjusting the treble

- ⇒ Press the **AUDIO** button (6).  
“BASS” appears in the display.
- ⇒ Press the **>** button (8) repeatedly until “TREBLE” appears in the display.
- ⇒ Press the **V** or **Λ** button (8) to adjust the treble.

When you have finished adjusting the setting,

- ⇒ press the **AUDIO** button (6).

### Setting the left/right volume distribution (balance)

To adjust the left/right volume distribution (balance),

⇨ press the **AUDIO** button (6).

“BASS” appears in the display.

⇨ Press the **>** button (8) repeatedly until “BAL” appears in the display.

⇨ Press the **V** or **^** button (8) to adjust the balance (right/left).

When you have finished adjusting the setting,

⇨ press the **AUDIO** button (6).

### Adjusting the front/rear volume distribution (fader)

To adjust the front/rear volume distribution (fader),

⇨ press the **AUDIO** button (6).

“BASS” appears in the display.

⇨ Press the **>** button (8) repeatedly until “FADER” appears in the display.

⇨ Press the **V** or **^** button (8) to adjust the fader (front/rear).

When you have finished adjusting the setting,

⇨ press the **AUDIO** button (6).

### Equalizer presets

This device is equipped with an equalizer that has been preset with settings for the “ROCK”, “POP” and “CLASSIC” music styles.

To select an equalizer preset,

⇨ press the **AUDIO** button (6).

“BASS” appears in the display.

⇨ Press the **>** button (8) repeatedly until “POP”, “ROCK”, “CLASSIC” or “EQ OFF” appears in the display.

⇨ Press the **V** or **^** button (8) to select one of the presets or select “EQ OFF” to switch off the equalizer. If you select one of the presets, it is shown continuously in the display.

When you have finished adjusting the setting,

⇨ press the **AUDIO** button (6).

## X-BASS

You can use the X-Bass feature to boost the bass at low volume levels.

The selected X-Bass setting affects all the audio sources (radio, CD, CD changer or AUX).

You can set the X-BASS boost in steps ranging from 1 to 3.

“XBASS OFF” means that the X-BASS function is switched off.

### Adjusting the X-BASS boost

- ⇒ Press the **X-BASS** button (9).
- ⇒ Press the **V** or **^** button (8) repeatedly until the setting that you want appears in the display.

When you have finished adjusting the setting,

- ⇒ press the **X-BASS** button (9).

## Configuring the level display

The level display temporarily provides you with a symbolic representation of the volume and audio settings whilst you are adjusting them.

When you are not changing any settings, the level display depicts the peak music/speech output. You can switch the level display on/off.

- ⇒ Press the **MENU** button (7).

“MENU” appears in the display.

- ⇒ Press the **V** or **^** button (8) repeatedly until “PEAK LVL” appears in the display.

- ⇒ Press the **<** or **>** button (8) to switch between “PEAK ON” and “PEAK OFF”.

When you have finished adjusting the setting,

- ⇒ press the **MENU** button (7) twice.

## External audio sources

**Instead** of connecting a CD changer, you can connect another audio source equipped with a line output. Audio sources can, for example, be portable CD players, MiniDisc players or MP3 players.

If you want to connect an external audio source, you will need an adapter cable. You can obtain this cable (Blaupunkt no.: 7 607 897 093) from your authorised Blaupunkt dealer.

### Note:

- If no CD changer is connected, the AUX input must be activated in the menu.

## Switching the AUX input on/off

- Press the **MENU** button (7).  
“MENU” appears in the display.
- Press the **▼** or **▲** button (8) repeatedly until “AUX OFF” or “AUX ON” appears in the display.
- Press the **<** or **>** button (8) to switch AUX on/off.

When you have finished adjusting the setting,

- press the **MENU** button (7).

### Note:

- If the AUX input is activated, you can select it by pressing the **SRC** **⌚** button (13). “AUX INPUT” then appears in the display.

## Specifications

### Amplifier

Output power: 4 x 25 watts sine in accordance with DIN 45 324 at 14.4 V  
4 x 45 watts max. power

### Tuner

Wavebands in Europe:

FM : 87.5 - 108 MHz  
MW : 531 - 1 602 kHz  
LW : 153 - 279 kHz

FM frequency response:

35 - 16,000 Hz

### CD

Frequency response:

20 - 20,000 Hz

### Pre-amp out

4 channels: 2 V

### Input sensitivity

AUX input: 2 V / 6 kΩ

### Weight:

1.33 kg

Subject to changes!



**Bitte den ausgefüllten Gerätepass sicher aufbewahren!**

**Please keep the filled-in radio pass in a safe place!**

**Prière de conserver soigneusement la carte d'autoradio remplie !**

**Tenete per favore il libretto di apparecchio, debitamente riempito, in un posto sicuro!**

**Bewaar de ingevulde apparaatpas op een veilige plaats!**

**Vänligen förvara ifyllt apparatpass på säker plats!**

**¡Favor guardar el documento del aparato debidamente llenado en un lugar seguro!**

**Por favor, guardar o cartão preenchido do aparelho num lugar seguro!**

**Det udfyldte apparatpas opbevares et sikkert sted!**

Country:	Phone:	Fax:	WWW:
Germany	(D) 0180-5000225	05121-49 4002	http://www.blaupunkt.com
Austria	(A) 01-610 39 0	01-610 39 391	
Belgium	(B) 02-525 5444	02-525 5263	
Denmark	(DK) 44 898 360	44-898 644	
Finland	(FIN) 09-435 991	09-435 99236	
France	(F) 01-4010 7007	01-4010 7320	
Great Britain	(GB) 01-89583 8880	01-89583 8394	
Greece	(GR) 210 94 27 337	210 94 12 711	
Ireland	(IRL) 01-46 66 700	01-46 66 706	
Italy	(I) 02-369 62331	02-369 62464	
Luxembourg	(L) 40 4078	40 2085	
Netherlands	(NL) 0800 400 1010	0800 400 1040	
Norway	(N) 66-817 000	66-817 157	
Portugal	(P) 2185 00144	2185 00165	
Spain	(E) 902 52 77 70	91 410 4078	
Sweden	(S) 08-7501850	08-7501810	
Switzerland	(CH) 01-8471644	01-8471650	
Czech. Rep.	(CZ) 02-6130 0446	02-6130 0514	
Hungary	(H) 76 511 803	76 511 809	
Poland	(PL) 0800-118922	022-8771260	
Turkey	(TR) 0212-335 06 71	0212-346 00 40	
USA	(USA) 800-950-2528	708-6817188	
Brasil			
(Mercosur)	(BR) 0800 7045446	+55-19 3745 2773	
Malaysia			
(Asia Pacific)	(MAL) +604-6382 474	+604-6413 640	

## Gerätepass

Name: .....

Typ: **7 646** .....

Serien-Nr.: **BP** .....

 **BLAUPUNKT**

Blaupunkt GmbH, Robert-Bosch-Straße 200, D-31139 Hildesheim

